

DUPLEX Easy

Compact ventilation units

with heat recovery and EC fans

Intended use

The new heat recovery units DUPLEX Easy are supplied in three sizes:

- DUPLEX 250 Easy
- DUPLEX 300 Easy
- DUPLEX 400 Easy

The units are intended for the comfort ventilation of all types of residential and civil premises. They are particularly suitable for low-energy and passive houses and flats in apartment buildings with a decentralized ventilation system.

General description

The casing of the unit is made of environmentally friendly EPP (expanded polypropylene), which is also characterized by minimal moisture absorption and stability over a wide range of temperatures. The basic version of DUPLEX Easy unit consist of EPP housing, counter-flow heat exchanger made of plastic (efficiency up to 93 %), two free wheel type fans with electronic EC control, G4 (optionally F7) supply and exhaust air filters upstream the heat recovery exchanger. Depending the type on control system, the unit can be equipped with several different functions and accessories (see the chart on page 4). The Construction of the unit provides high variability, and the same unit can be installed in 5 different positions (2 floor-standing, 2 underceiling and 1 floor-standing flat). Condensate outlets on DUPLEX Easy are ready for all possible mounting positions. Connecting ports are of a circular type for flexible or rigid ducts with thermal bridging reduction.



DUPLEX EASY

Advantages of DUPLEX Easy units

- High efficient EC fans
- High heat recovery efficiency of the counter flow heat exchanger
- Great thermal and mechanical parameters of the housing
- Very flat unit (280 mm) suitable for underceiling installation
- An option of the mirror-wise change of the right hand / left hand side position
- Light weight of the unit
- Ease of filter changing
- Frost protection (optionally built-in)
- Bypass with actuator (optionally built-in)
- Four types of control systems (see page 4)

- 1 Counter-flow heat exchanger with efficiency up to 93 %
- 2 EC fans
- 3 Bypass damper with actuator
- 4 Air filters G4 or F7
- 5 Circular port
- 6 EPP housing

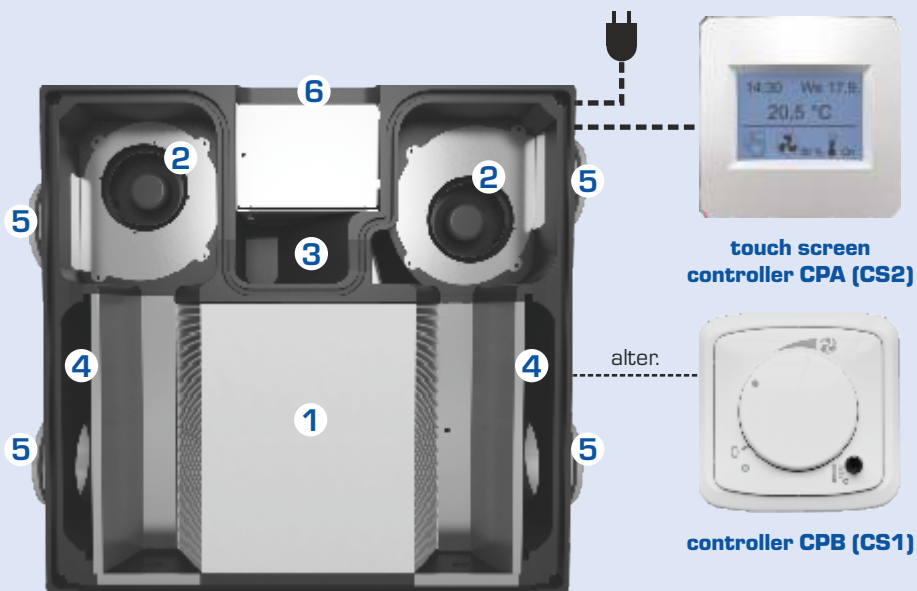

A



Atrea®

RESIDENTIAL VENTILATION & HEATING

ATREA s.r.o., Čs. armády 32
466 05 Jablonec n. Nisou
Czech Republic



www.atrea.eu

Tel.: +420 483 368 111
Fax: +420 483 368 112
E-mail: atrea@atrea.eu

TECHNICAL DATA – DUPLEX EASY

PERFORMANCE PARAMETERS EASY

DUPLEX 250 EASY

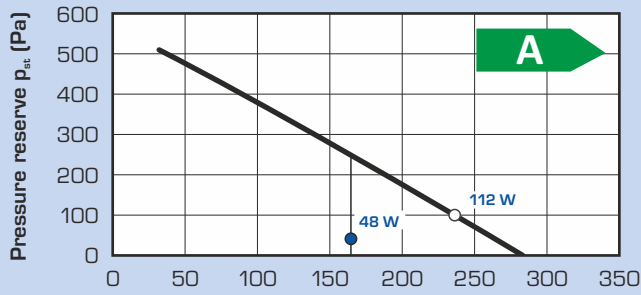

DUPLEX 300 EASY

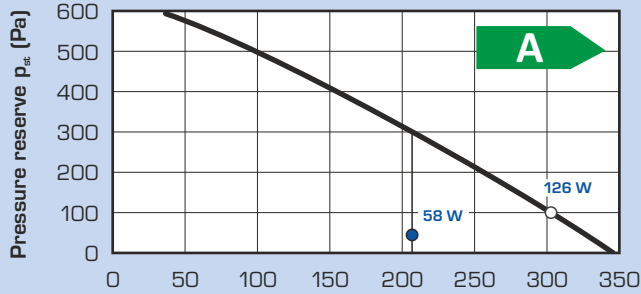

DUPLEX 400 EASY

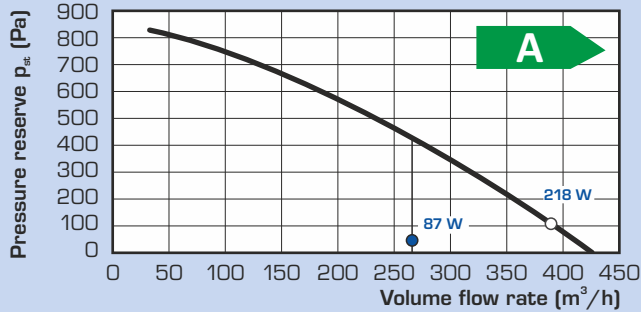

Legend:

- Q_{ref} Reference flow rate
 - Q_{max} Maximum flow rate
- Pressure reserve with filter G4*

* Max. pressure reserve curve is shown

* Electrical power consumption is shown (both fans and control system)

HEAT RECOVERY EFFICIENCY EASY

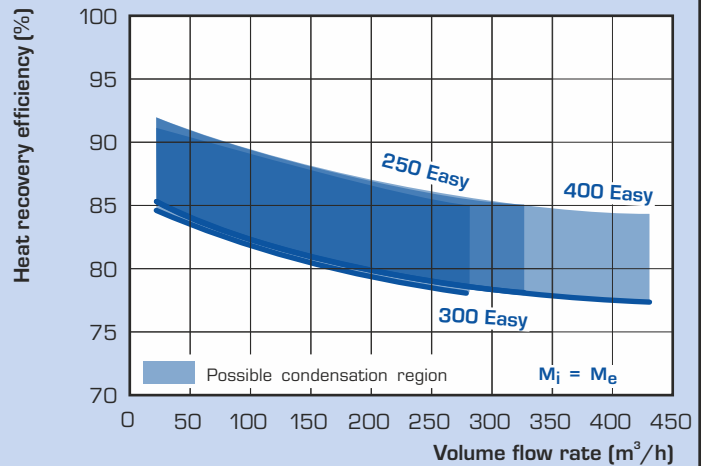

TECHNICAL DATA EASY

DUPLEX Easy		250	300	400
Supply air – max.	m ³ /h	280	330	430
Extract air – max.	m ³ /h	280	330	430
Max. heat recovery efficiency	%	93	93	93
Max. power consumption of fans	W	120	120	220
Width B	mm	660	820	820
Dimension D	mm	425	435	435
Diameter of connecting ports	mm	ø 160	ø 160	ø 160
Weight	kg	20	21	21
By-pass	-	optional		
Voltage	V	230 / 50 Hz		
Supply air filter class	-	G4 (alter: F7)		
Condensate drain	mm	6x ø 14 (depending on position)		

¹⁾ All types of control system that are built within the unit commonly include at least two inputs, so the electrical signals from human operation of lights or other equipment, that automatically control the performance of the unit, can be connected. These inputs or other types of sensors must always be connected (e.g. CO₂, VOC, rH etc.)

²⁾ Maximum flow rate at 100 Pa

³⁾ The value is at reference flow rate it means 70 % of maximum flow rate and 50 Pa

⁴⁾ Acoustic values of the units with SK cover – see accessories

ACOUSTIC POWER L_w AND ACOUSTIC PRESSURE L_p

Type	Working point	Acoustic power L _w [dB(A)]					Acoustic pressure L _p [dB(A)] at distance of 3 m
		inlet e ₁	inlet i ₁	outlet e ₂	outlet i ₂	unit	
DUPLEX 250 Easy	200 m ³ /h (100 Pa)	53	53	74*	74*	60/54**	40 / 33**
DUPLEX 300 Easy	250 m ³ /h (100 Pa)	51	51	74*	74*	61/54**	40 / 34**
DUPLEX 400 Easy	300 m ³ /h (100 Pa)	50	50	75*	75*	62/55**	42 / 35**

To achieve acceptable acoustic values it is necessary to install air distribution with guaranteed acoustic attenuation.

* Approximately it is possible to reduce sound power on outlet e₂, i₂ to following values:

- L_w = 52 dB (A) – using 1 m of soundproofed pipe
- L_w = 43 dB (A) – using 2 m of soundproofed pipe
- L_w = 37 dB (A) – using 3 m of soundproofed pipe

** Acoustic values of the units with SK cover – see accessories

DIMENSIONAL DIAGRAM EASY

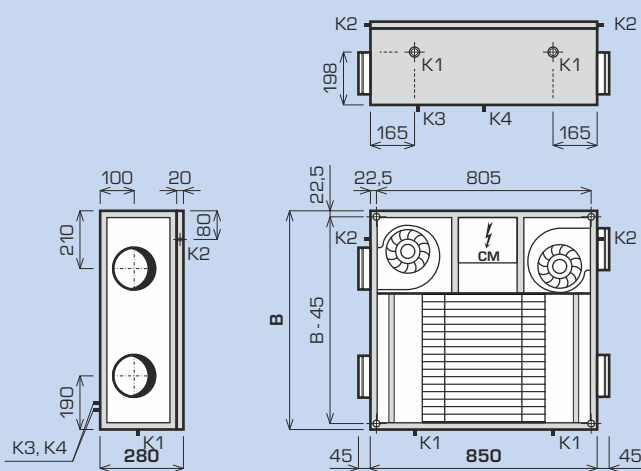

K1 ... Condensate drain for floor-standing position

K2 ... Condensate drain for underceiling position

K3 ... Condensate drain for floor-standing flat position

K4 ... Condensate drain for floor-standing flat position

* For both floor-standing and underceiling position use only one appropriate condensate drain.

** For floor-standing flat use both condensate drains.

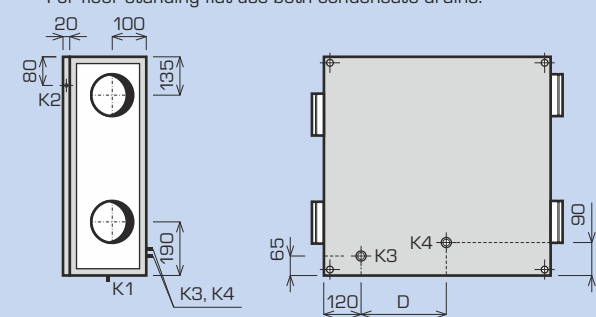

MOUNTING POSITIONS

FLOOR-STANDING

UNDERCEILING

FLOOR-STANDING FLAT

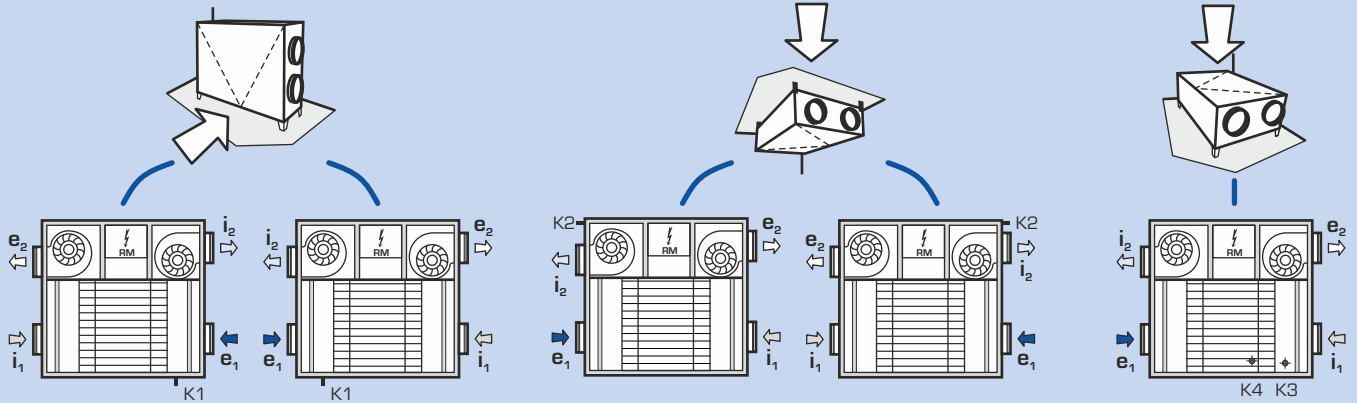

Note: DUPLEX Easy units are supplied for versatile position mounting – the unit can be installed in all positions (floor-standing, underceiling and floor-standing flat). The "right hand" and "left hand" position according to the figure above is selected simply by relocating the operating sensor and by reconnecting unit fans.

LEGEND

- ➔ e₁ Fresh outdoor air suction
- ➔ e₂ Fresh filtered air outlet
- ➔ i₁ Exhaust air suction
- ➔ i₂ Exhaust air outlet
- CM Control module

INSTALLATION

DUPLEX Easy – underceiling position

New DUPLEX Easy units have a very flat design that allows installing them into even very low suspended ceilings. The minimum requirements for suspended ceiling height is 305 mm. A plasterboard lid is fitted below the unit; in bathrooms the lid must be airtight and the entire suspended ceiling steam tight.

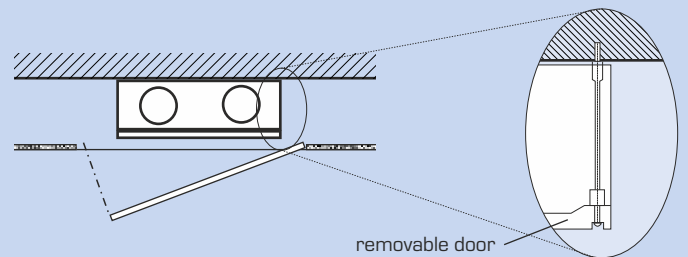
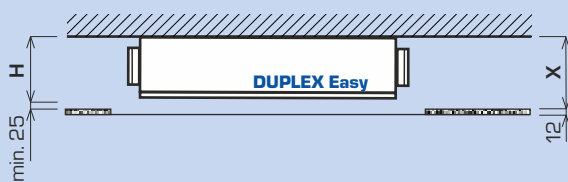

CONDENSATE DRAIN

Condensate drainage

During heat recovery – heat regaining – moisture is condensed during the cooling of exhaust air. Water condensates on the walls of the heat recovery exchanger, further increasing heat recovery efficiency. Condensate runs out of the heat recovery exchanger in the direction of air being extracted and is drained from the DUPLEX unit into a sewer system. For correct functioning and drainage the unit must be separated from the sewer system using a siphon of a sufficient height, the recommended minimum being 150 mm. Small condensation drain pumps may be used. The unit must be installed within the specified gradient for each position.

FLOOR-STANDING

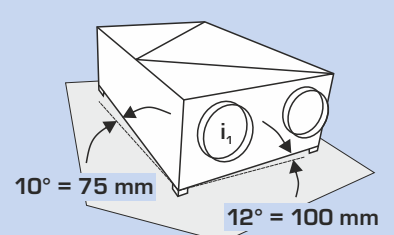
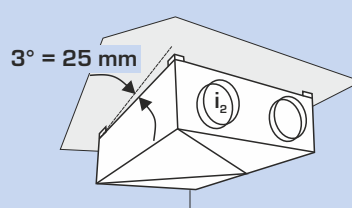
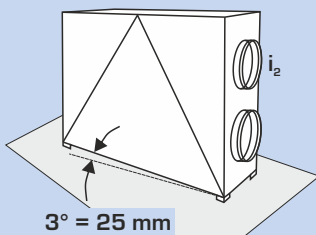
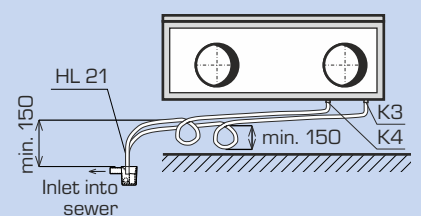
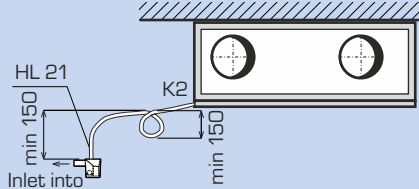
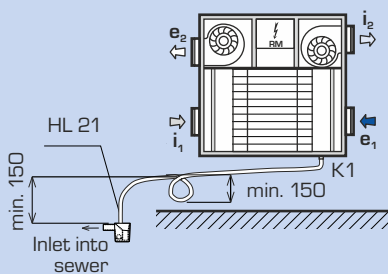

UNDERCEILING

FLOOR-STANDING FLAT



CONTROLS

SUMMARY OF DUPLEX EASY CONTROL SYSTEMS

Type	Description	Controller
„Without control system“	All electrical components are wired to a junction box inside the unit. This solution is suitable for applications with computer-based control system (BMS) installed in buildings that controls and monitors the building's mechanical and electrical equipment.	<ul style="list-style-type: none"> • Without controller • Frost protection – fan disbalance • Automatic by-pass with servo drive
“CS1“ controls	This is the starting level of the DUPLEX Easy control system that gives basic functions of controlling of the unit. CS1 version comes with an installed controller.	<ul style="list-style-type: none"> • Volume flow • Frost protection – preheater (EPO-PTC) or fan disbalance • Reheating (EPO-PTC) • Automatic by-pass with servo drive • Analogue input (0–10 V) for air quality sensor • Minimum and maximum speed preselection • Inlet and outlet shut-off damper control 
“CS2“ controls	This version meets higher requirements and is fully ready for modern comfort living. This level of our control system comes with a touch screen controller.	<ul style="list-style-type: none"> • Automatic or manual mode • Frost protection – preheater (EPO-PTC) or fan disbalance • Reheating (EPO-PTC) • Analogue input (0–10 V) for air quality sensor • Inlet and outlet shut-off damper control • Manual or weekly program • Room temperature display • Party mode, holiday mode • Filter change notice • Minimum and maximum speed preselection 
“RD5“ controls	This ATREA proprietary control system meets all requirements for high-demand controlled ventilation. The great advantage is the integrated web server as standard.	<ul style="list-style-type: none"> • Frost protection – preheating (EPO-PTC) or fan disbalance • Optional constant flow function • Modbus TCP • Analogue / digital input • Right or left configuration just through the controller setting • Weekly programming • A ventilation run-down and delay time option • Boost and party mode • Combined heating and preheating (EPO-PTC) – electrical or water based 

ELECTRIC HEATERS EPO-PTC

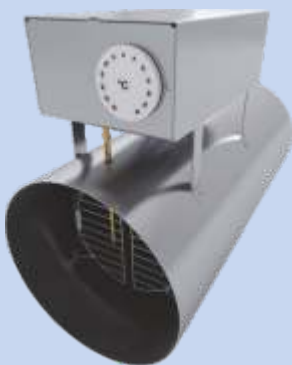

- Used as a **preheater** to preheat fresh air; to be installed in ducts on fresh air inlet
- Used as an **afterheater** to reheat supply air; to be installed in ducts after the unit
- Integrated PTC (Positive Temperature Coefficient) heating elements
- Housing includes a terminal board and internal wiring
- Includes two protection thermostats – a reversible one and a safety irreversible one
- Contains an interference-free SSR relay as standard
- Perforated metal filter to protect heater from gross particles (easily cleanable)
- Galvanized sheet metal housing

	ø D (mm)	Voltage (V)	Power input (kW)
EPO-PTC 160 / 0,4 kW	ø 160	1x 230 V~	0,4
EPO-PTC 160 / 0,7 kW	ø 160	1x 230 V~	0,7
EPO-PTC 160 / 1,7 kW	ø 160	1x 230 V~	1,7

OPTIONAL ACCESSORIES - SK COVER



SK / 250

SK / 300

Special two-piece cover made of galvanized metal sheet (silver color) for better acoustic parameters of the DUPLEX Easy.