

# DUPLEX Flexi 2

## Compact ventilator units with heat recovery

The ventilation units of the **new** original patented **DUPLEX Flexi** design range are intended for comfort ventilation with the highest heat recovery efficiency and hot-air heating in all kinds of civil and residential buildings. They are made in four sizes: **DUPLEX 1100, 1600, 2600 and 3600 Flexi**.

The units are available in multi-purpose design, i.e. for installation on the floor or beneath the ceiling. In addition the unit sides may be interchanged, i.e. supply and exhaust air ports can be used conversely, allowing installation flexibility.

The units can optionally be fitted with a hot water heating coil or a chiller (water-based or direct) to be installed directly on the unit. The duct downstream the unit may be equipped with an electric re-heater; an electric pre-heater can also be installed upstream the unit.

The **DUPLEX 1600** also includes alternative ports that can be interchanged and used on site as side ports.

From the construction point of view all units are compact sets containing in a single cabinet two independently powered, highly efficient EC fans with flexibly mounted motors a counterflow high-efficiency heat recovery core with large heat-transfer area, a by-pass damper with an actuator, removable supply and extract air cartridge filters M5 or F7 and a condensate drain pan, all in the same housing.

The front door enables easy access to all components. Inlet and outlet ports are round or rectangular based on the unit type. The housing is manufactured with white painted sheet metal panels with polyurethane insulation ( $U = 0,82 \text{ Wm}^{-2}\text{K}^{-1}$ ).

As an option the units can be equipped with a complete control system, including a connection to the internet or to a third party management system – for detailed information see the section on controls.



**DUPLEX Flexi 2**

### Features of the DUPLEX Flexi:

- Great thermal insulation of the casing (class T2)
- Reduced thermal bridging (class TB1)
- low profile significantly simplifies installations such as ceiling-suspended applications
- extreme compactness of new unit types ensures up to 60 % space reduction in comparison with modular units
- low purchase cost
- multipurpose unit design (floorstanding / ceiling-suspended installations) simplifies ordering and on-site installations
- low power input – high EC fan efficiency
- high heat recovery efficiency thanks to new generation heat recovery exchangers
- low noise
- light weight
- different types of control systems based on application complexity; fully integrated into the unit
- the units meet hygienic requirements in accordance with the VDI 6022
- the units meet stringent efficiency and effectiveness criteria and are certified by the renowned Passive House Institute (Germany) \*
- the units meet requirement in accordance with Commission regulation (EU) No. 1253/2014 (Ecodesign) \*

\* in the defined working area



### OPERATING MODES

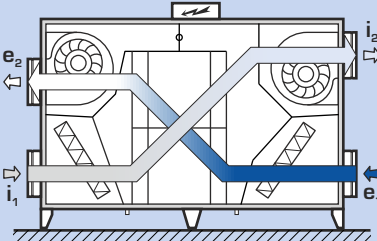

1. equal-pressure ventilation with heat recovery

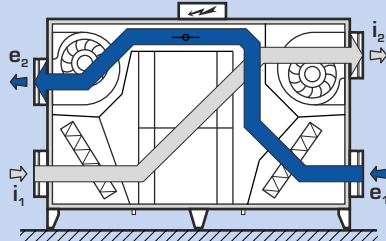

2. equal-pressure ventilation without heat recovery (through by-pass)

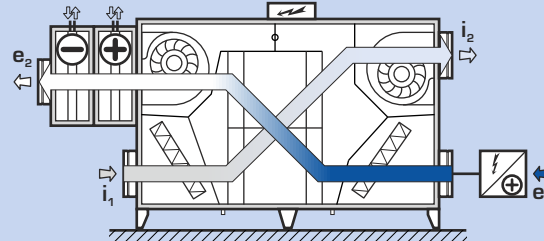

3. equal-pressure ventilation with heating / cooling / or preheating

→ e<sub>1</sub> ... outdoor air (ODA)  
↻ e<sub>2</sub> ... supply air (SUP)

↻ i<sub>1</sub> ... extract air (ETA)  
↻ i<sub>2</sub> ... exhaust air (EHA)

### SELECTION SOFTWARE



For detailed selection of DUPLEX units, accessories and control system we recommend to use our special selection software. To select a heat recovery exchanger you can use our special selection software. Download it from our webpage [www.atrea.eu](http://www.atrea.eu) or contact us at our mail address.



UNIT VENTILATORS & HEAT RECOVERY

ATREA s.r.o., Čs. armády 32  
466 05 Jablonec n. N.  
Czech Republic



[www.atrea.eu](http://www.atrea.eu)

Phone: +420 483 368 111  
Fax: +420 483 368 112  
E-mail: [export@atrea.eu](mailto:export@atrea.eu)

# PERFORMANCE CURVES

## TECHNICAL DATA

Unit		DUPLEX 1100 Flexi	DUPLEX 1600 Flexi	DUPLEX 2600 Flexi	DUPLEX 3600 Flexi
Nominal airflow	m <sup>3</sup> h <sup>-1</sup>	1 000	1 900	2 500	5 000
Nominal external static pressure	Pa	300	300	260	400
Power input at nominal operating point	W	670	1 370	1 520	4 630
Recovery efficiency <sup>1)</sup>	%	see curve	see curve	see curve	see curve
Weight	kg	150	205	280	370
Fan number	-	2	2	2	2
Power supply	V	230	230	230	400
Frequency	Hz	50	50	50	50
Max. power input	W	780	1 480	1 660	5 100
Fan speed	min <sup>-1</sup>	3 400	2 960	2 470	2 970
Filtration class	-	F7 / M5	F7 / M5	F7 / M5	F7 / M5

<sup>1)</sup> based on air volume flow – see curve

<sup>2)</sup> based on accessories

## PERFORMANCE CURVES

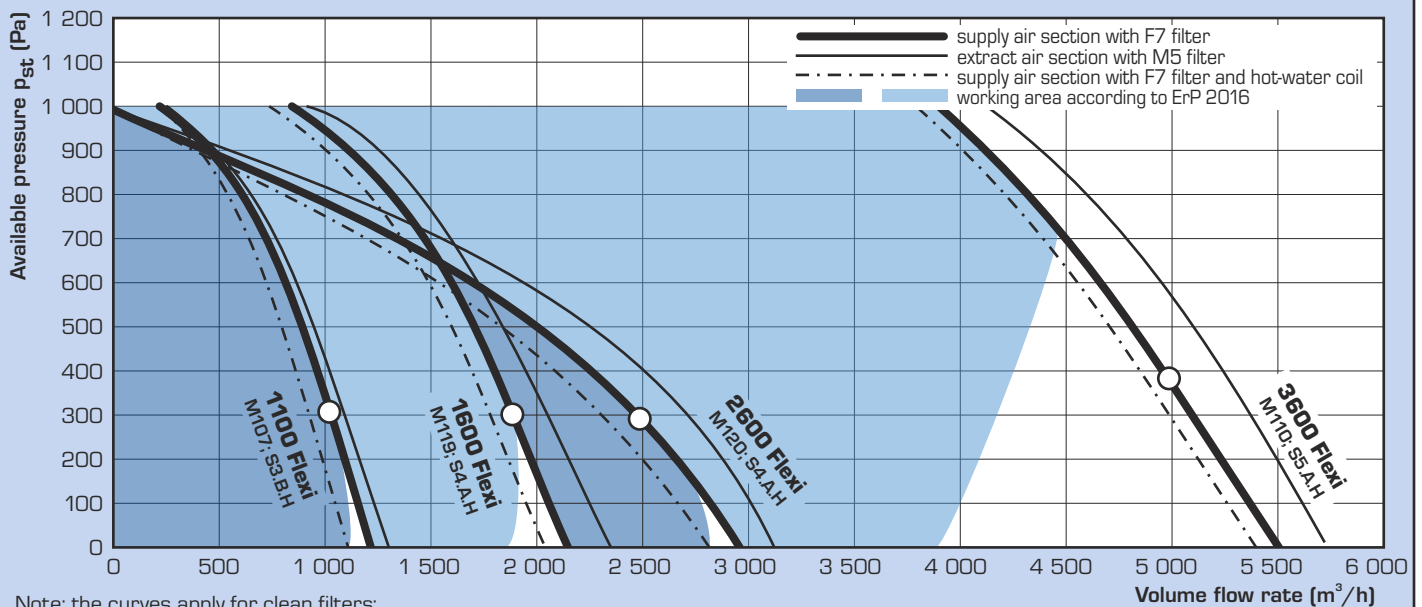

Note: the curves apply for clean filters;

dirty filter pressure loss is considered at 200 Pa or at an air flow reduction of max. 20 % (in accord. EN 13053)

## HEATING AND COOLING CAPACITY, RECOVERY EFFICIENCY

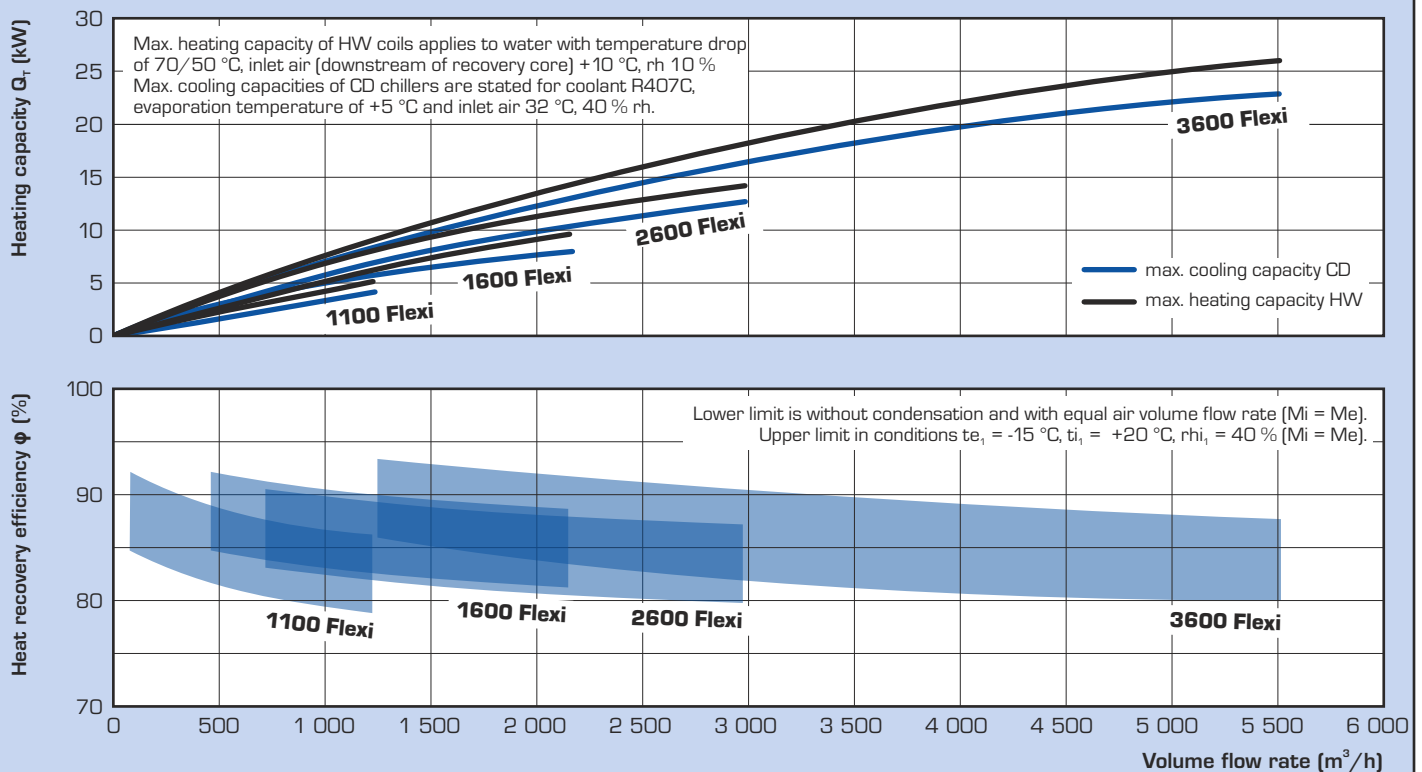

# DIMENSIONS AND CONNECTION PORTS

## DUPLEX 1100, 1600 FLEXI (CIRCULAR PORTS)

### UNIT ONLY

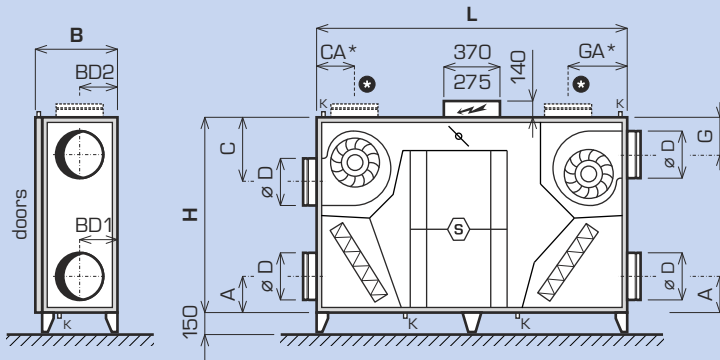

### UNIT WITH HEATING COIL AND / OR CHILLER

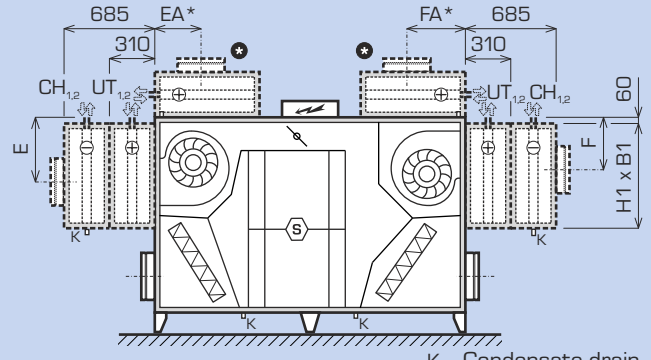

K ... Condensate drain

Unit	L	H	B	ø D	BD1	BD2	A	C	G	E	F	H1	B1	CA*	GA*	EA*	FA*
1100 Flexi	1 700	1 100	395	250	175	159	225	359	246	402	290	595	350	-	-	-	-
1600 Flexi	2 020	1 270	490	315	210	210	240	418	283	478	343	700	440	227	362	283	418

UT<sub>1,2</sub> ... Heating coil connection; CH<sub>1,2</sub> ... Chiller connection

⊙ ... port / heater position possible only in DUPLEX 1600 Flexi

### ROUND CONNECTION PORTS

Basic port  
(inlet, outlet)

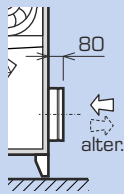

Port with a flexible connection  
(inlet, outlet; delivered separately)

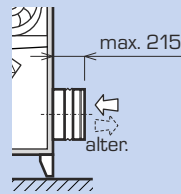

Port with a damper  
(inlet only; delivered separately)

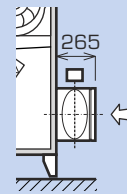

Port with a damper and flexible connection  
(inlet only; delivered separately)

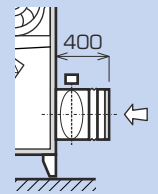

Note: For detailed design and technical data we recommend using our dedicated selection software.

## DUPLEX 2600, 3600 FLEXI (RECTANGULAR PORTS)

### UNIT ONLY

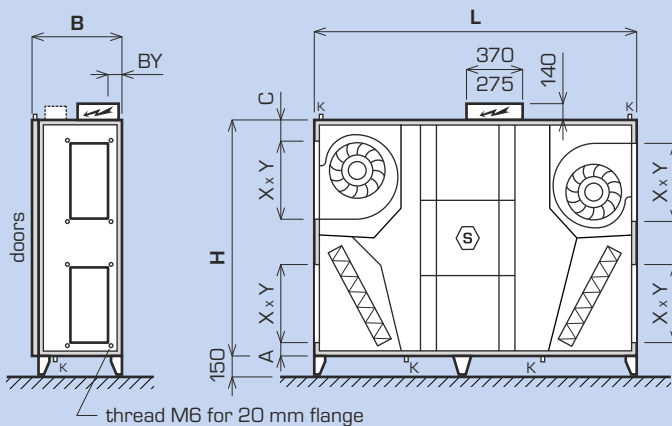

thread M6 for 20 mm flange

### UNIT WITH HEATING COIL AND / OR CHILLER

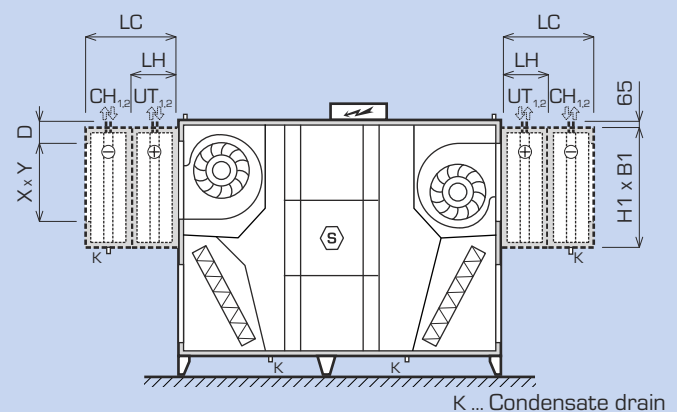

K ... Condensate drain

Unit	L	H	B	X	Y	BY	A	C	D	LH	LC	H1	B1
2600 Flexi	2 150	1 570	570	500	250	90	100	160	228	390	760	825	520
3600 Flexi	2 450	1 660	780	600	300	163	75	145	178	450	880	825	730

LH ... Stand-alone heating coil; LC ... Stand-alone chiller or heating coil with chiller; X x Y ... Connecting port dimensions

UT<sub>1,2</sub> ... Heating coil connection; CH<sub>1,2</sub> ... Chiller connection

### RECTANGULAR CONNECTION PORTS

Basic port  
(inlet, outlet)

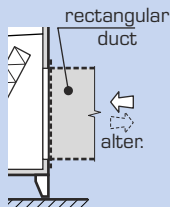

Port with a flexible connection  
(inlet, outlet; delivered separately)

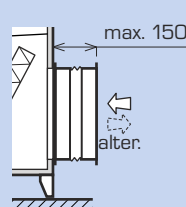

Port with a damper  
(inlet only; delivered separately)

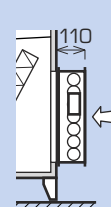

Port with a damper and flexible connection  
(inlet only; delivered separately)

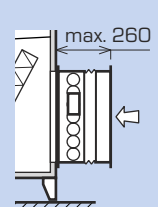

Note: For detailed design and technical data we recommend using our dedicated selection software.

# INSTALLATION CONFIGURATION

## INSTALLATION POSITIONS AND PORT CONFIGURATIONS

The units are available in multipurpose design, allowing the unit to be installed on the floor or beneath the ceiling. For both the floor and ceiling-suspended installation, the standard support steel legs are used. Chillers must always be suspended separately.

Each unit is fitted with several condensate drain pipes as standard. During installation the respective drain should be selected. Chillers have their own condensate drains. The condensate drains used must be connected into a sewer system. During installation the respective drain should be selected.

In addition, unit sides can be interchanged, i.e. supply and exhaust air ports can be used conversely.

This ensures high installation flexibility on site.

Hot water heating coil HW.2 and /or a water-based or direct chiller (to be fitted directly on to the unit) or an EPD-V electric heating coil (to be installed in to the duct) may be optionally connected to the unit.

Note: The chiller may not be fitted to units with spigots in upward position  $e_2$ .

In addition the DUPLEX 1600 unit includes alternative ports ( $e_2$  and  $i_2$ ) that can be interchanged on site and used as side ports.

For a detailed unit design we recommend a special DUPLEX selection software be used; available at [www.atrea.eu](http://www.atrea.eu).

### FLOOR-STANDING POSITION

- the unit is installed using the adjustable legs supplied

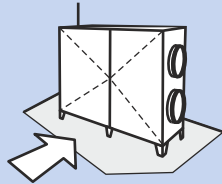

K ... Condensate drain



... Chiller not to be fitted in this position

$e_1$  ... outdoor air (ODA)

$i_1$  ... extract air (ETA)

$e_2$  ... supply air (SUP)

$i_2$  ... exhaust air (EHA)

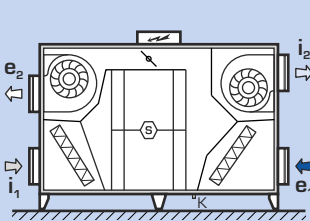

1100 Flexi, 1600 Flexi  
2600 Flexi, 3600 Flexi

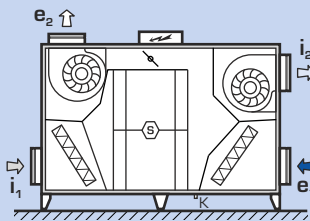

1600 Flexi

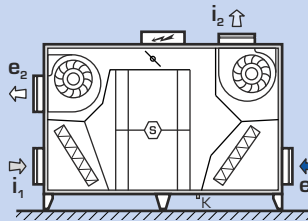

1600 Flexi

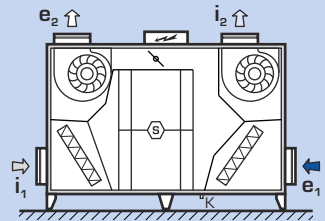

1600 Flexi

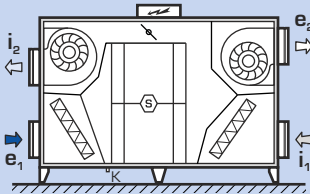

1100 Flexi, 1600 Flexi  
2600 Flexi, 3600 Flexi

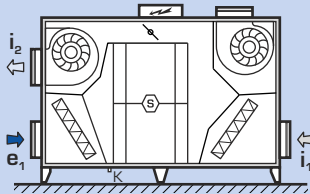

1600 Flexi

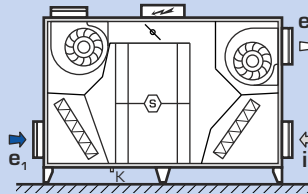

1600 Flexi

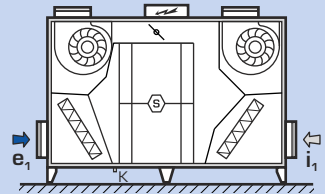

1600 Flexi

### CEILING-SUSPENDED POSITION

- the unit is installed using supplied hangers

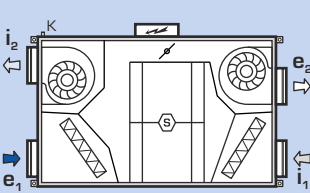
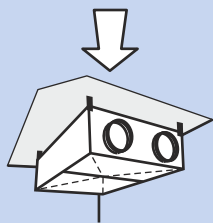

1100 Flexi, 1600 Flexi  
2600 Flexi, 3600 Flexi

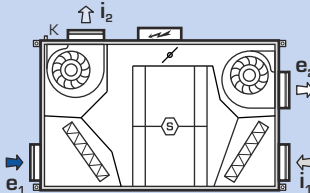

1600 Flexi

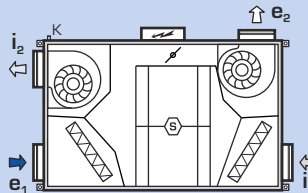

1600 Flexi

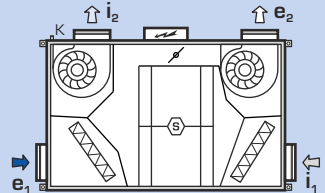

1600 Flexi

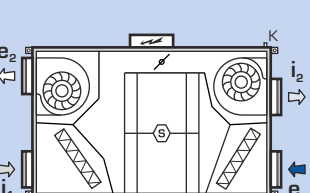

1100 Flexi, 1600 Flexi  
2600 Flexi, 3600 Flexi

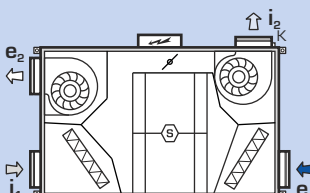

1600 Flexi

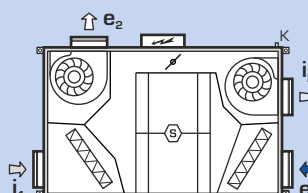

1600 Flexi

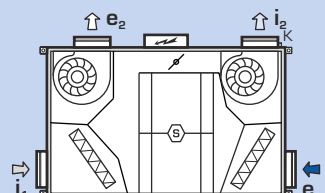

1600 Flexi

## MANIPULATION SPACE

When installing DUPLEX units it is necessary to allow for the recommended free space around the unit for manipulation. A minimum space of 150 mm is needed under the unit to install a DN 32 condensate drain pipe. A trap with a minimum height of 150 mm must be installed before connecting the pipe to a building sewer. The recommended space is easily ensured when the standard support steel legs are used.

Space in front of the unit is required for opening the door, filter changing and access to all components that require service.

Minimum manipulation space required for the hinged door is marked on respective drawings.

For all units 600 mm free manipulation space from an electric control panel, is required in accordance with respective standards.

### Manipulation space, unit configuration

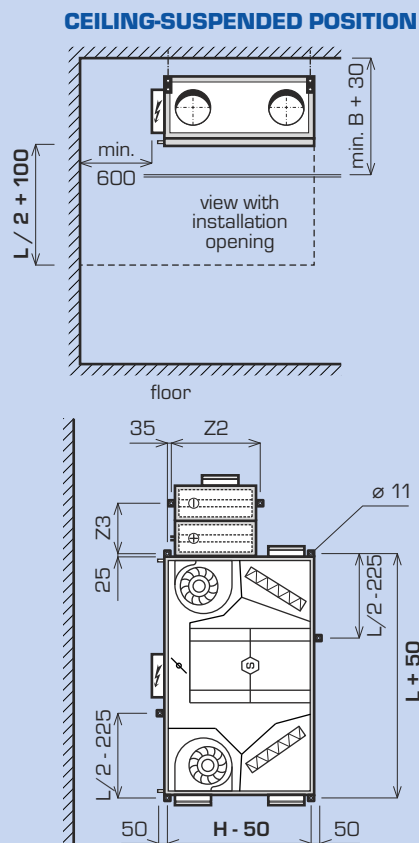
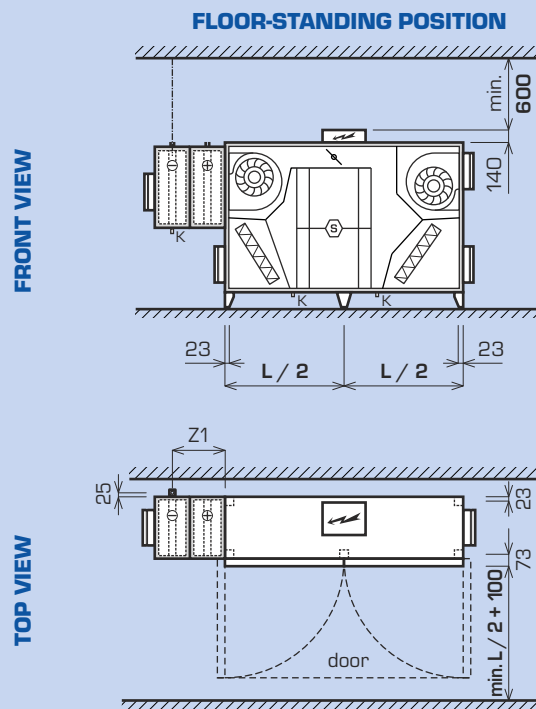

Unit	Support legs	Suspension point - Chiller	Suspension point - Unit	Suspension point - Chiller
<b>1100 Flexi</b>	4 pcs	1 pc	4 pcs (in corners)	2 pcs
<b>1600 Flexi</b>	5 pcs	1 pc	4 pcs (in corners)	2 pcs
<b>2600 Flexi</b>	6 pcs	1 pc	4 pcs (in corners)	2 pcs
<b>3600 Flexi</b>	6 pcs	1 pc	6 pcs (in corners and in the middle)	2 pcs

Unit	L	Z1	Z2	Z3	B	H
<b>1100 Flexi</b>	1 700	418	625	392	395	1 100
<b>1600 Flexi</b>	2 020	418	750	392	490	1 270
<b>2600 Flexi</b>	2 150	566	875	540	570	1 570
<b>3600 Flexi</b>	2 450	625	875	600	780	1 660

# ACOUSTICS, BASIC UNIT

## SOUND POWER LEVEL $L_w(A)$ (dB)

**DUPLEX 1100 Flexi**

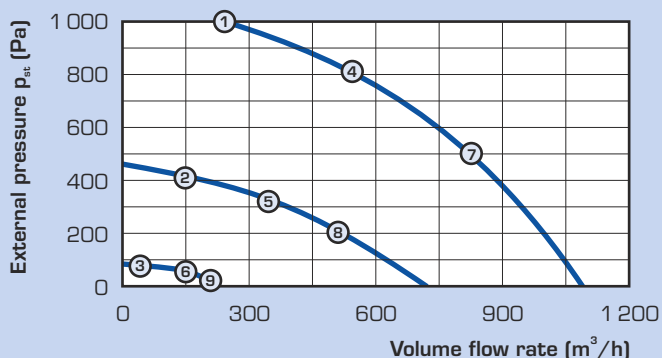

**DUPLEX 1600 Flexi**

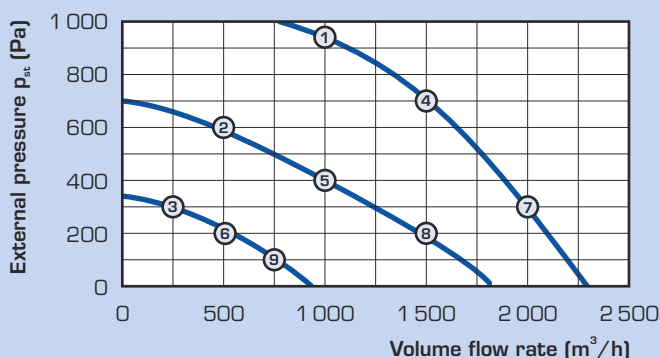

**DUPLEX 2600 Flexi**

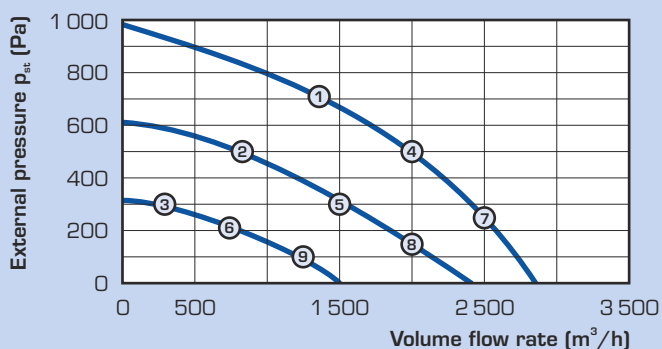

**DUPLEX 3600 Flexi**

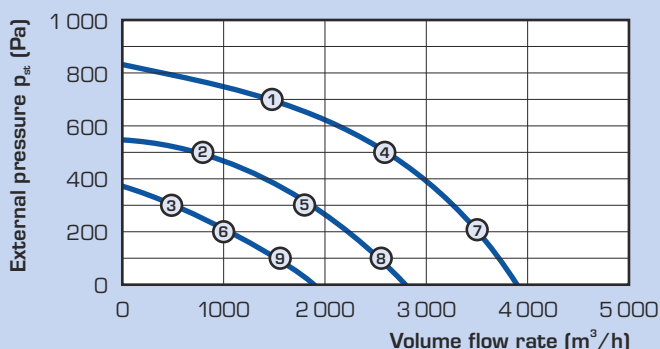

point	DUPLEX 1100 Flexi			DUPLEX 1600 Flexi			DUPLEX 2600 Flexi			DUPLEX 3600 Flexi		
	outlet (dB(A))	inlet (dB(A))	surround (dB(A))	outlet (dB(A))	inlet (dB(A))	surround (dB(A))	outlet (dB(A))	inlet (dB(A))	surround (dB(A))	outlet (dB(A))	inlet (dB(A))	surround (dB(A))
1	84	59	60	85	63	65	84	61	66	81	59	64
2	77	48	51	79	57	60	78	57	62	73	53	57
3	63	34	36	67	47	50	70	51	54	66	47	50
4	85	60	62	84	61	65	84	59	67	83	57	63
5	79	49	52	77	54	58	77	54	60	74	50	53
6	66	35	36	63	43	46	67	46	50	65	45	48
7	89	62	65	85	60	65	86	60	67	87	59	65
8	82	52	54	79	55	61	80	55	61	77	53	54
9	69	36	36	64	42	47	67	45	50	66	45	47

Note: for detailed calculation we recommend a special selection software be used.

## DUPLEX - BASIC UNIT



### Housing

The housing unit is manufactured with panels of painted sheet metal and a polyurethane insulation of 30 mm thickness ( $U = 0,82 \text{ Wm}^{-2}\text{K}^{-1}$ , T2 class, TB1. Front door enables easy access to all built-in components.

**DUPLEX xxxx Flexi**



### Fans

For both the supply and exhaust air, high-performance EC fans are used (direct drive wheel in semispiral housing with fitted spring-mounted electric motor). Due to the fans; the units are highly efficient with very low specific power input.

**Me.xxx; Mi.xxx**



### Heat recovery core

The units are equipped with a newly designed high-performance heat recovery core. This is made of thin plastic plates with high recovery efficiency up to 93 %.

**S3.B.H / S4.A.H / S5.A.H**



### By-pass damper („B“)

The heat recovery core bypass, includes an actuator. When opening the by-pass damper, airflow through the recovery core closes automatically to avoid heat transfer.

**B.x**



## OPTIONAL ACCESSORIES (BASIC OVERVIEW)



### Shutoff damper e,; i,

Ke.xxx; Ki.xxx

Shutoff dampers are fitted on inlet ports. The dampers are available in different sizes based on unit ports and actuator types – the standard type is LM 24A and the type with spring return is LF 24 (to be shut off in case of power cuts). An option delivered separately.



### Flexible connection

H.P

Flexible connection for round or rectangular ports in the unit port sizes. An option delivered separately.

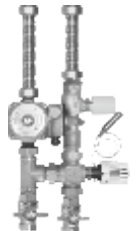

### Heating coil hydraulic kit

RE-HW.4, RE-HW.3

Its function is to control heating capacity of a heating coil. It consists of a three-speed pump, two globe shutoff valves and connection pipes. Further equipment depends on the type:  
 – RE-HW.4 – three-way mixing valve with an actuator for digital control system  
 – RE-HW.3 – three-way diverting valve with a thermostatic valve for electric control system



### Tube manometers

A.MFF

Accessory for filters for simple view of current pressure drop. The tube manometers are obligatory for hygienic unit design in accordance with the VDI 6022. An option delivered separately.



### Electric heating coils EPO-V

EPO-V

Heating coils for round or rectangular ducts to be connected to DUPLEX units. All switching elements are included as standard. Control is provided through the DUPLEX (RD or DC) unit control system. For capacities, dimensions and installation requirements see separate technical sheets. An option delivered separately.



### Water chiller CW

CW.xxx

Water chillers can be installed externally on to the unit's casing, to either a chamber with a hot water heating coil or a free chamber. For systems up to 1.0 MPa. An option delivered separately.



### Control modes for water chillers

R-CW.3

Designed to control the cooling capacity of water chillers. The R-CW.3 with a 3-way fitting has a 3-way Belimo ball valve with a Belimo TR24-SR servo drive and two ball stop valves. An option delivered separately.



### Air filtration

Fe.xxx; Fi.xxx

The DUPLEX series are equipped with filter cartridges as standard (F7 / M5 class filters – supply / exhaust). Other available filter combinations are M5 / M5 and F7 / F7



### HW hot-water Heating coils

HW.xxx

Separately, optionally delivered hot-water heating coils to be mounted on the housing unit. For systems up to 110 °C and 1,0 Mpa. An option delivered separately.



### Electric preheaters EPO-V

EPO-V

EPO-V electric heating coils to provide the antifreeze protection of the heat recovery exchanger when equal-pressure ventilation is continuously required. It is installed inside a duct on the outdoor supply air side of the unit (e<sub>1</sub>). Control is provided through the DUPLEX (RD or DC) unit control system. When installing the heating coil requirements specified in a separate technical sheet must be adhered to. An option delivered separately.



### Spare cartridge filters

NFK.x

Replacement filter cartridges in different sizes based on the unit type. Available in M5 and F7 filtration class.



### Constant air flow and pressure

A.CF.XXX

Manometers reading fan pressure together with controls, enables intelligent fan control of preselected airflow. This accessory assumes the unit is equipped with digital controls of DC or RD type. Using a second manometer (optional accessory) in the supply air duct enables the user to control constant pressure in the supply duct. An option delivered separately.



### Direct chillers CD

CD.xxx

Direct chillers can be installed externally on to the unit's casing, to either a chamber with a hot water heating coil or a free chamber. An option delivered separately.



### Free chamber VK

VK.xxx

A chamber to be installed on to the unit's casing on the supply air outlet e<sub>2</sub>. It is intended for homogenizing air flow upstream the chiller, and it is used only when no HW hot water heating coil is installed. An option delivered separately.

# CONTROLS

The DUPLEX Flexi ventilator units can be equipped with built-in controls providing complete functionality of the unit with its accessories. Thanks to integration of the controls into the unit simple commissioning of the unit and full functionality is guaranteed. There is no risk with compatibility of components during installation.

The controls enable connection to management systems – more information in the description of the respective

controls and the selection software. Units do not have to be equipped with controls – individual components are only connected to a terminal block.

A special ATREA selection software may be used to generate all control type selection including drawings printouts.

## SUMMARY OF DUPLEX FLEXI CONTROL SYSTEMS

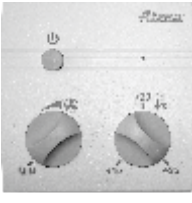
Type	Use	Controller
„Without controls“	<ul style="list-style-type: none"> <li>– all components with power supply are connected to a terminal block outside the unit</li> <li>– more components are included upon customer's request (exact actuator type, sensors, thermostats, pressure switches etc.)</li> <li>– good for applications where third party control is supplied separately – e.g. large buildings with building management systems</li> </ul>	– not applicable
„RD5“ controls	<p><b>Standard functions of the „RD5“ controls</b></p> <ul style="list-style-type: none"> <li>– EC fan speed control (based on selected mode)</li> <li>– automatic by-pass damper position (heat and cool recovery)</li> <li>– evaluates and prevents emergency limits based on measured temperature</li> <li>– ventilation and temperature weekly program setting</li> <li>– A web server and an Ethernet interface built in as standard connection for remote internet communication</li> <li>– inputs for switching using 230 V (4 inputs – 3 delayed, 1 instantenious) – switch e.g. from bathrooms etc.</li> <li>– optional connection of CO<sub>2</sub> or RH sensor – max. 2 sensors with a switch or 0–10 V output</li> <li>– outputs for electric preheater and heater control (pulse 10 V) or hot-water control (0–10 V)</li> </ul> <p><b>Additional RD-IO module</b></p> <ul style="list-style-type: none"> <li>– optional manometer connection to ensure constant airflow control (see Constant airflow and pressure control on previous page)</li> <li>– constant pressure control</li> <li>– cooling control outputs (DX- or chilled-water cooling), possibly for a heat pump</li> </ul> <p><b>Additional RD-K module</b></p> <ul style="list-style-type: none"> <li>– additional inputs and outputs significantly extending control system functions</li> </ul> <p><b>BACnet / KNX converter</b></p> <ul style="list-style-type: none"> <li>– optional converter allowing connection to supervisory control system via BACnet or KNX protocol</li> </ul>	<p><b>CP Touch</b></p>  <p><b>CP10RT</b></p>  <p><b>Web server (as standard)</b></p> 