

VARIANT

Kitchen hoods with air supply

The VARIANT kitchen hoods provide efficient waste air exhaustion with filtration, and at the same time, treated fresh air supply for kitchens of all sizes and sets, including optional automatic control.

The kitchen hoods with the VARIANT type supply are delivered as complete sets, made from stainless steel plates as per ČSN 17240 (AISI 304), with 400 x 400 mm cartridge fat filters providing the capture efficiency up to 88 %. By default, the hoods are equipped with built-in fluorescent lighting.

In front of the hoods, 275 x 275 mm angular, adjustable, inlet branches are installed for the treated fresh air supply.

Both suction and supply branches of circular or rectangular shape are exclusively located on the top. For the connected piping, thermal and acoustic insulation is recommended (preferably Pitre or ALP), with respect to cleaning and maintenance options.

The VARIANT type hoods are combined with DUPLEX units located out of the kitchen area, alternatively with standalone fans, filtration, and heating.

The VARIANT hoods are hanged on M10 threaded rods fixed with spacer anchors to the ceiling, on the hood circumference. The VARIANT type kitchen hoods are delivered with a standard height of 435 mm, with plan dimensions as required by the customer in the given scope.

The VARIANT hoods feature with compact, sound design, and their integration of exhaustion and air supply in a single device eliminates other unsightly lines in the kitchen area.



VARIANT

Automatic operation control

If ordered, the VARIANT hoods can be equipped with a complete micro-processor based operation control system. The system consists of a micro-processor based control module with differential temperature sensors, built-in the SM terminal board above the hood. An OP control panel is delivered independently for the remote setup of the hood operation, as well as for the RG switchgear controlling the supply and exhaust fans. The automatic control of VARIANT hoods provides for economical operation of the ventilation depending on current heat production in the kitchen. Only in case of higher air temperature difference between the air below the hood and in the kitchen area, reduced speed of exhaustion and supply fans is automatically started. When the temperature difference continues to increase, maximum speed of the both fans is started. After the adjustable difference is reduced, the fans are automatically slowed down, or completely stopped, as applicable.

FUNCTIONAL DIAGRAM

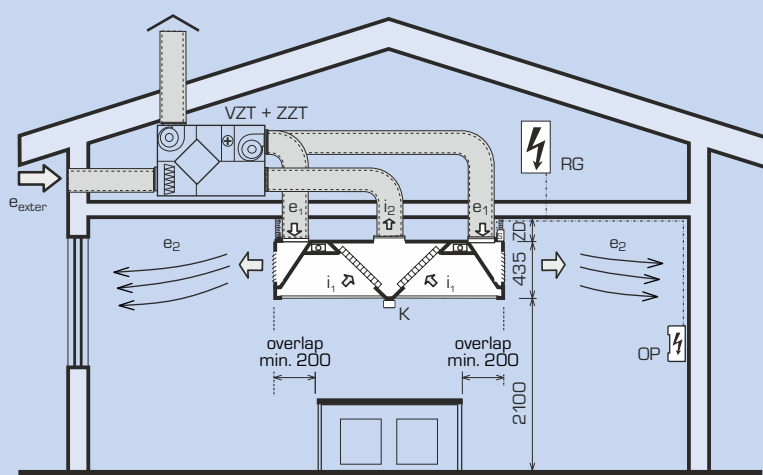

LEGEND

- VZT+ZZT** ... DUPLEX Basic compact ventilation unit with heat recovery
- i_1 ... effluent air inlet
 - i_2 ... effluent air outlet
 - e_{exter} ... external air inlet
 - e_1 ... fresh heated air inlet
 - e_2 ... fresh heated air outlet
 - ZD** ... hood cover (such as plasterboard)
 - K** ... fat capture receiver
 - S** ... terminal board
 - SM** ... terminal board with built-in micro-processor module
 - OP** ... automatic control panel
 - RG** ... automatic control switchgear

SELECTION SOFTWARE



A special selection software can also be used for designing the hoods, created in compliance with VDI 2052 directive (Germany). You can find this program on our website www.atrea.eu.

Atrea®

KITCHEN VENTILATION

ATREA s.r.o., Čs. armády 32
466 05 Jablonec n. Nisou
Czech Republic



www.atrea.eu

Phone: +420 483 368 111
Fax: +420 483 368 112
E-mail: atrea@atrea.eu

VARIANT-N

VARIANT-N (WALL MOUNTED)

LEGEND

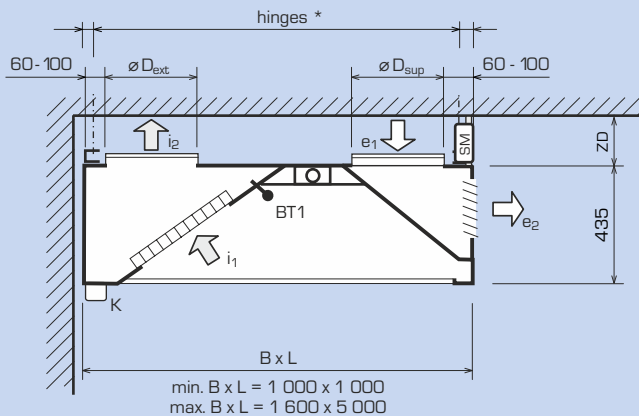

- i_1 ... effluent air inlet
- i_2 ... effluent air outlet
- e_1 ... fresh heated air inlet
- e_2 ... fresh heated air outlet
- B x L ... width x length of hood
- $B_1 \times L_1$... hinges spacing
- ZD ... hood cover (such as plasterboard)
- $\varnothing D_{ext}$... exhaust ports (circular or rectangular sections)
- $\varnothing D_{sup}$... supply ports (circular or rectangular sections)
- ... fluorescent lighting
- K ... fat capture receiver
- SM ... terminal board with built-in micro-processor module
- BT1 ... automatic control operating temperature sensor (internal)
- BT2 ... automatic control operating temperature sensor (area) - located on the side of the hood
- * ... hinges layout drawing depending on the hood size, on request

For hoods with length L > 3 000 mm, 2 pieces of branches e_1 and i_2 are delivered, located in 1/4 of the length from edges.

DIMENSIONS

hood dimensions [mm]				maximum number of filters	maximum number of louvres	maximum flow rate [m ³ /h]	supply/suction maximum pressure loss [Pa]	Lighting power input	Number of hinges
length L	width B								
1- exhaust 1- supply									
1 000	1 000	1 250	1 600	2	3	1 160	70 / 100	2 x 18 W	4
1 200	1 000	1 250	1 600	2	3	1 160	72 / 101	2 x 18 W	4
1 400	1 000	1 250	1 600	3	4	1 740	72 / 102	2 x 18 W	4
1 600	1 000	1 250	1 600	3	5	1 740	77 / 117	2 x 36W	4
1 800	1 000	1 250	1 600	4	5	2 320	74 / 121	2 x 36W	4
2 000	1 000	1 250	1 600	4	6	2 320	83 / 123	2 x 58 W	6
2 200	1 000	1 250	1 600	5	7	2 900	72 / 106	2 x 58 W	6
2 400	1 000	1 250	1 600	5	7	2 900	72 / 94	2 x 58 W	6
2 600	1 000	1 250	1 600	6	8	3 480	67 / 101	2 x 58 W	6
2 800	1 000	1 250	1 600	6	9	3 480	67 / 91	2 x 58 W	6
2- exhaust 2- supply									
3 000	1 000	1 250	1 600	7	9	4 060	72 / 108	2 pcs 2 x 36 W	8
3 200	1 000	1 250	1 600	7	10	4 060	77 / 111	2 pcs 2 x 36 W	8
3 400	1 000	1 250	1 600	8	11	4 640	71 / 102	2 pcs 2 x 36 W	8
3 600	1 000	1 250	1 600	8	11	4 640	72 / 105	2 pcs 2 x 36 W	8
3 800	1 000	1 250	1 600	9	12	5 220	71 / 107	2 pcs 2 x 58 W	8
4 000	1 000	1 250	1 600	9	13	5 220	76 / 114	2 pcs 2 x 58 W	8
4 200	1 000	1 250	1 600	10	13	5 800	72 / 106	2 pcs 2 x 58 W	8
4 400	1 000	1 250	1 600	10	14	5 800	72 / 100	2 pcs 2 x 58 W	8
4 600	1 000	1 250	1 600	11	15	6 380	72 / 100	2 pcs 2 x 58 W	8
4 800	1 000	1 250	1 600	11	15	6 380	72 / 94	2 pcs 2 x 58 W	8
5 000	1 000	1 250	1 600	12	16	6 960	72 / 90	2 pcs 2 x 58 W	8

IMPORTANT WARNINGS

- B class gas loads must be lead to stack, no way to the hood
- flue gas crossing, if any, through the hood must be consulted
- delivery of hoods from length L > 3 500 mm is recommended in disassembled state, with respect to their difficult transport and handling
- take care of sufficient overlapping of the hood over the outline of loads

SIZE LINE

The hood can be delivered with the following dimensions:

- length L = 1 000 to 5 000 mm (by 50 mm).
- width B = 1 000 to 1 600 mm (by 50 mm).

WEIGHT

$$G_{hood} \cong L \times B \times (25 \text{ to } 32 \text{ kg} / \text{m}^2 \text{ of plan})$$

$$G_{filter} \cong 1,6 \text{ kg} / \text{pc}$$

VARIANT-S (MIDDLE)

LEGEND

a) type design

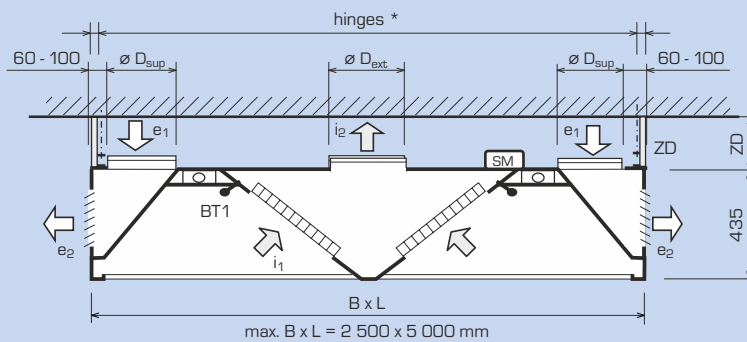

b) large area hoods

- see a separate catalog sheet

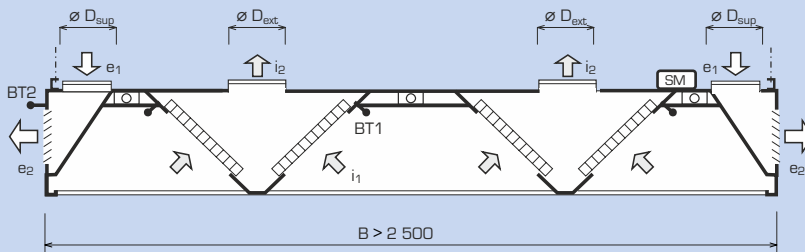

- i_1 ... effluent air inlet
- i_2 ... effluent air outlet
- e_1 ... fresh heated air inlet
- e_2 ... fresh heated air outlet
- $B \times L$... width x length of hood
- $B_1 \times L_1$... hinges spacing
- ZD ... hood cover (such as plasterboard)
- $\varnothing D_{ext}$... exhaust ports (circular or rectangular sections)
- $\varnothing D_{sup}$... supply ports (circular or rectangular sections)
-  ... fluorescent lighting
- K ... fat capture receiver
- SM ... terminal board with built-in micro-processor module
- BT1 ... automatic control operating temperature sensor (internal)
- BT2 ... automatic control operating temperature sensor (area) - located on the side of the hood
- * ... hinges layout drawing depending on the hood size, on request

DIMENSIONS

hood dimensions (mm)					maximum number of filters	maximum number of louvres	maximum flow rate (m ³ /h)	supply/suction maximum pressure loss (Pa)	Lighting power input	Number of hinges
length L	width B									
1- exhaust 2- supply										
1 000	1 800	1 950	2 250	2 500	4	6	2 320	70 / 100	2 pcs 2 x 18 W	6
1 200	1 800	1 950	2 250	2 500	4	6	2 320	72 / 101	2 pcs 2 x 18 W	6
1 400	1 800	1 950	2 250	2 500	6	8	3 480	72 / 102	2 pcs 2 x 18 W	6
1 600	1 800	1 950	2 250	2 500	6	10	3 480	76 / 114	2 pcs 2 x 36 W	6
1 800	1 800	1 950	2 250	2 500	8	10	4 640	70 / 109	2 pcs 2 x 36 W	6
2 000	1 800	1 950	2 250	2 500	8	12	4 640	83 / 123	2 pcs 2 x 58 W	8
2 200	1 800	1 950	2 250	2 500	10	14	5 800	72 / 106	2 pcs 2 x 58 W	8
2 400	1 800	1 950	2 250	2 500	10	14	5 800	77 / 106	2 pcs 2 x 58 W	8
2 600	1 800	1 950	2 250	2 500	12	16	6 960	70 / 109	2 pcs 2 x 58 W	8
2 800	1 800	1 950	2 250	2 500	12	18	6 960	70 / 98	2 pcs 2 x 58 W	8
2- exhaust 4- supply										
3 000	1 800	1 950	2 250	2 500	14	18	8 120	70 / 104	4 pcs 2 x 36 W	10
3 200	1 800	1 950	2 250	2 500	14	20	8 120	75 / 106	4 pcs 2 x 36 W	10
3 400	1 800	1 950	2 250	2 500	16	22	9 280	70 / 100	4 pcs 2 x 36 W	10
3 600	1 800	1 950	2 250	2 500	16	22	9 280	74 / 110	4 pcs 2 x 36 W	10
3 800	1 800	1 950	2 250	2 500	18	24	10 440	70 / 104	4 pcs 2 x 36 W	10
4 000	1 800	1 950	2 250	2 500	18	26	10 440	75 / 109	4 pcs 2 x 58 W	10
4 200	1 800	1 950	2 250	2 500	20	26	11 600	73 / 110	4 pcs 2 x 58 W	10
4 400	1 800	1 950	2 250	2 500	20	28	11 600	73 / 103	4 pcs 2 x 58 W	10
4 600	1 800	1 950	2 250	2 500	22	30	12 760	70 / 106	4 pcs 2 x 58 W	10
4 800	1 800	1 950	2 250	2 500	22	30	12 760	72 / 104	4 pcs 2 x 58 W	10
5 000	1 800	1 950	2 250	2 500	24	32	13 920	71 / 104	4 pcs 2 x 58 W	10

IMPORTANT WARNINGS

- B class gas loads must be lead to stack, no way to the hood
- flue gas crossing, if any, through the hood must be consulted
- delivery of hoods from length L > 3,500 mm or B > 2,000 mm width is recommended in disassembled state, with respect to their difficult transport and handling
- take care of sufficient overlapping of the hood over the outline of loads

SIZE LINE

The hood can be delivered with the following dimensions:

- length L = 1 000 to 5 000 mm (by 50 mm).
- width B = 1 800 to 2 500 mm (by 50 mm).

WEIGHT

$$G_{hood} \cong L \times B \times (25 \text{ to } 32 \text{ kg} / \text{m}^2 \text{ of plan})$$

$$G_{filter} \cong 1,6 \text{ kg} / \text{pc}$$

SUPPLY PORTS

WINTER MODE

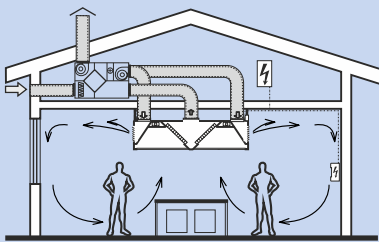

The air supply in the VARIANT line is provided using stainless steel branches. Each branch can simply be directed.

Winter time

Supply ports are adjusted upwards.

The outer supplied air (pre-heated in the exchanger) is exhausted below the kitchen ceiling, and has no immediate impact on the hood personnel.

Summer time

Supply ports are adjusted downwards.

The outer supplied air (without pre-heating) is exhausted askew downwards, and it creates the colder air curtain

SUMMER MODE

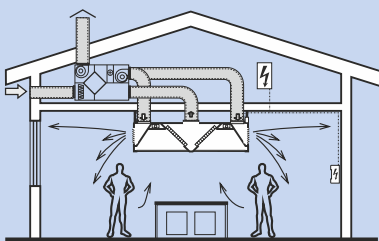

Dimensions of supply ports

The number of branches can be based on recommended flow rate through a single branch, depending on required reach of jet streams:

$$V_{dop} = 270 \text{ to } 540 \text{ m}^3/\text{h} / 1 \text{ pc}$$

Then, the resulting pressure loss is 7 to 40 Pa.

FAT FILTERS

By default, the hoods are equipped with VARIANT type fat filters with the size of 400 x 400 mm. They consist of 9-layered expanded metal, built-in a stainless steel frame. The number of filters is always determined based on the maximum anticipated flow rate in hoods using a diagram, so that the flow rate in a single filter is always within its optimum area. Finally, a check must be performed to see whether the calculated number of filters fits in the hood length physically.

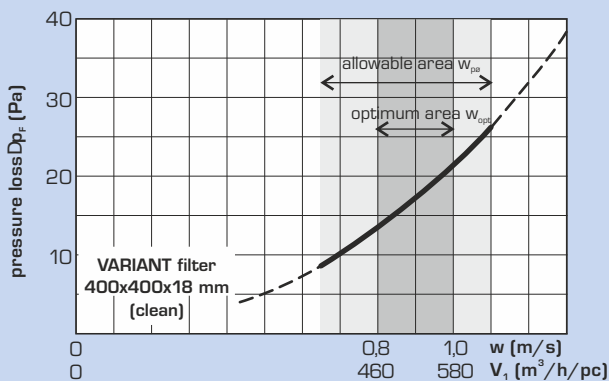

ANCHORING TO THE CEILING

The hoods are equipped with special fixtures to be hung on M10 threaded rods anchored to the ceiling using 14 / 10 mm spacer anchors (not in the scope of delivery). During the installation, the fixtures with notches allow for easy slipping-over the hanging rods with nuts, including simple locking of the hood height position. Number and types of hangers – see diagrams.

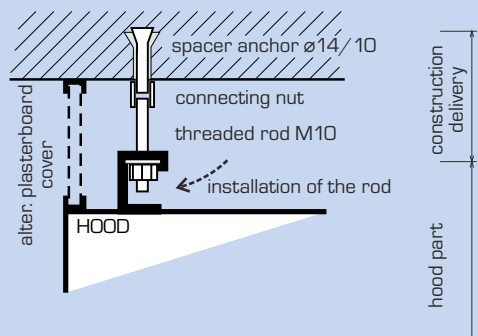

ELECTRIC CONNECTIONS

a) terminal board of the basic design (without any automatic control)

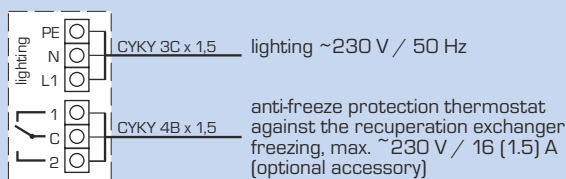

b) terminal board with built-in SM micro-processor based control module – see the Automatic Control chapter for detailed wiring diagram

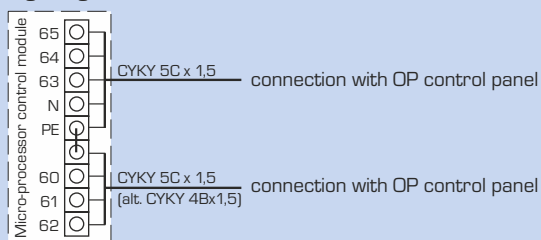

ORDERING DATA

Hood VARIANT-N - L x B (mm) - V_{ext} / V_{sup} (m³/h) - $\varnothing D_{ext} / \varnothing D_{sup}$ (mm), number of filters, delivery in parts (YES / NO), number and location of supply ports - automatic control YES / NO - SM, OP, switchboard RG - type, power input and type of supply and exhaust fan.